

IBK-1

ENSACHEUSE

CARACTÉRISTIQUES

- ▶ L'ENSACHEUSE ITV IBK-1 PERMET DE METTRE LA GLACE DANS DES SACS D'UNE MANIÈRE RAPIDE ET FACILE
- ▶ FABRIQUE EN ALUMINIUM ANODISÉ
- ▶ TUBE DE GLACE DE POLYSTYRENE ALIMENTAIRE
- ▶ SACS D'UNE CAPACITÉ DE 4KG (275x550mm)
- ▶ SACS FERMÉS PAR UN FIL PLASTIFIÉ

ACCESSOIRES (NON INCLUS)



KITS DE SACS



KITS DE FERMETURES



PELLE



BACS RECOMMANDES



S 160



S 220



S 350



S 400







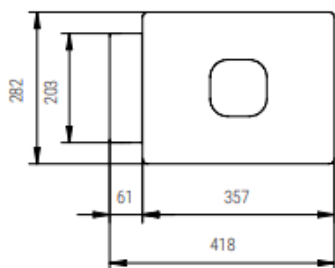
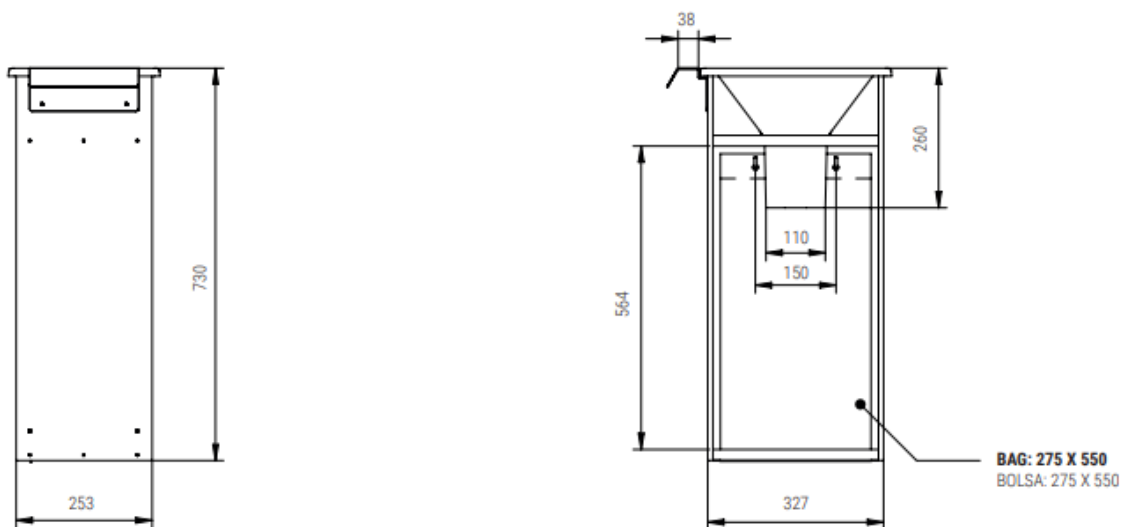

S 500

SCHÉMAS TECHNIQUES



* All measurements in mm.
* Todas las cotas en mm.

CONDITIONS DE FONCTIONNEMENT

MODELES												
	(mm)	(Kg)	(Lbs.)	(mm)	(mm)	(Kg)	(Kg)	(m ³)				
IBK-1	L : 550 P : - H : 80	4	8,8	L : 357 P : 274 H : 730	L : 377 P : 302 H : 742	5,85	7	0,08				