

# MEUBLE DE PREPARATION SUSHI GN 1/1

## Modèles MFEI-70 1/6

Pour bacs 1/6



MFEI70-180 1/6

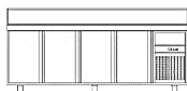

MFEI70-225 1/6

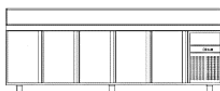

MFEI70-270 1/6

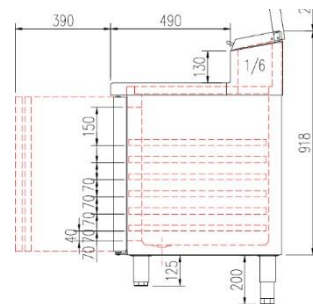

### CARACTERISTIQUES TECHNIQUES

- Extérieur inox AISI-304 18/10 (sauf partie arrière)
- Intérieur inox AISI-304 18/10 avec angles arrondis et fond embouti
- 230/1/50 (60hz sur demande : PVP +5%)
- Porte réversible avec rappel de porte, charnières inox et joint magnétique déclipable. Reste ouverte au-delà de 90°
- Contre-porte emboutie
- Dessus inox pouvant accueillir des bacs GN 1/6 profondeur 150 (sauf pour les 3 au-dessus du groupe en profondeur 65) avec couvercle rabattable
- Livré avec 1 clayette rilsan GN 1/1 et 1 jeu de glissières par porte réglable en hauteur
- Pieds inox réglables en hauteur de 135 à 210 mm
- Compresseur hermétique ventilé sur glissières
- Evaporateur entre portes ventilé traité anti-corrosion
- Thermostat électronique avec afficheur digital, spécial économie d'énergie
- Evaporation automatique des eaux de dégivrage
- Condenseur ventilé et extractible
- Isolation polyuréthane épaisseur 60 mm, densité 40kg/m<sup>3</sup> sans effet GWP ou ODP
- Alarme haute et basse température sur contrôleur digital
- Conditions de travail : 32°C ambiant
- Bacs non fournis

	Température	Nb portes	Capacité bacs GN 1/6	Dimensions (LxPxH mm)	Capacité (L)	Gaz	Puiss. frigo (W)	Conso. (W)
<b>MFEI70-180</b>	0°C/+8°C	3	10	1795x700x850	399	R134a*	485	511
						R290	1004	614
<b>MFEI70-225</b>		4	13	2245x700x850	543	R134a*	485	511
						R290	845	490
<b>MFEI70-270</b>	5	16	2695x700x850	686	R134a*	485	567	
					R290	845	490	

\* Non disponible pour le marché européen



### OPTIONS

- Clayette rilsan GN 1/1
- Jeu de 2 glissières inox GN 1/1 (L=560mm)
- Kit 4 ou 6 roulettes
- Serrure pour porte pleine
- Arrière inox meuble 3, 4, 5 portes
- Changement de gaz sur modèles positifs (R290 → R134a)
- Remplacement dessus inox par-dessus granit
- Supplément pour avoir le groupe à gauche du meuble

**MFEI 70-180**

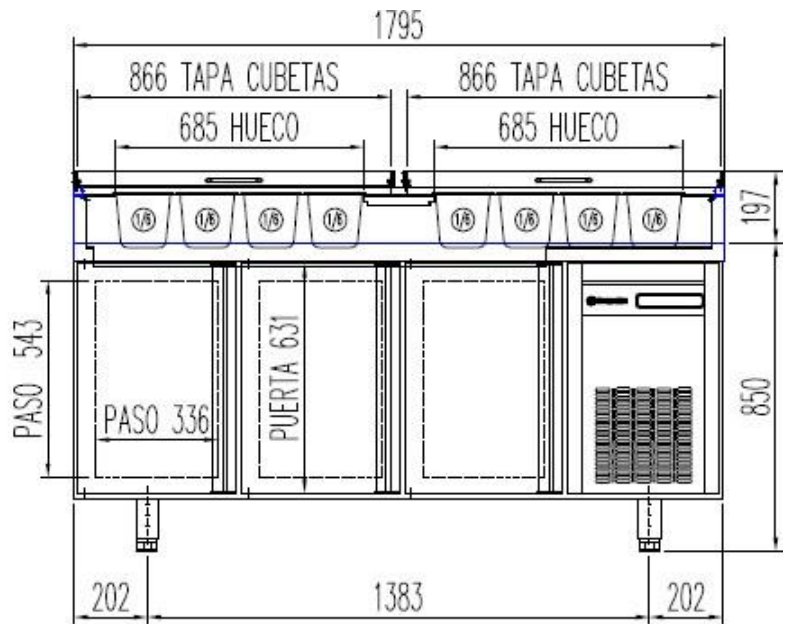
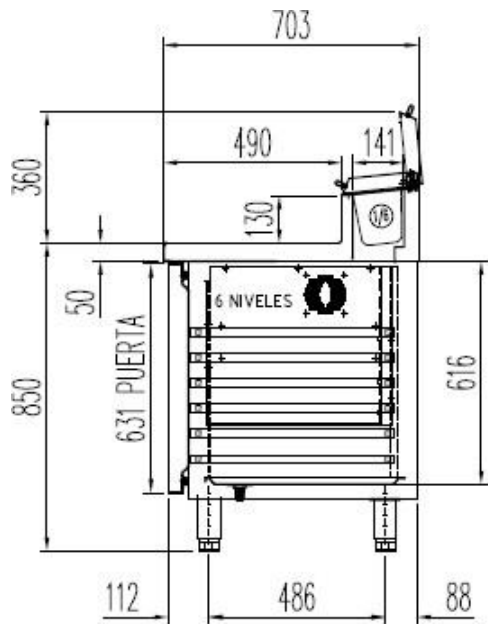

ENCIMERA CAPACIDAD HASTA  
 8 CUBETAS PROFUNDIDAD 150 mm.

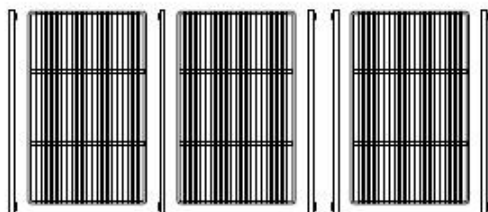
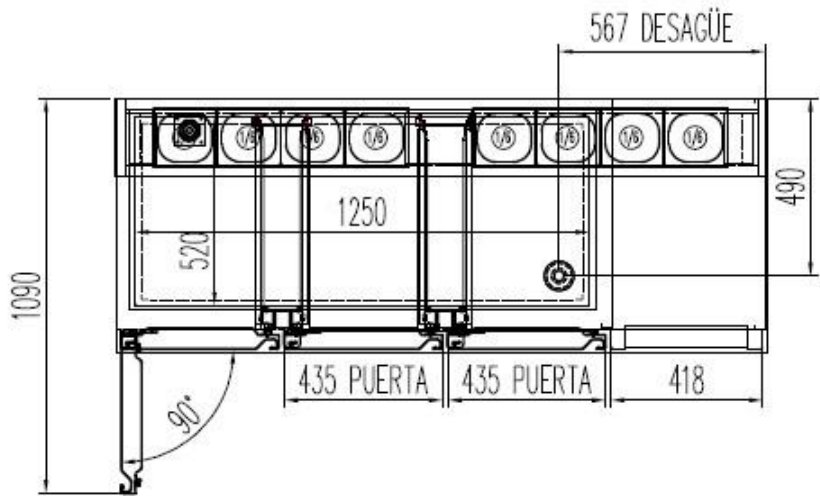
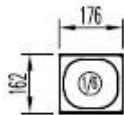

6027010003- PARRILLA ESTANTE 530 x325 mm GN 1/1  
 6033050027- JUEGO DE GUIAS EN "U" 562 mm

OPCIONAL  
 CAMBIO DE PATAS POR RUEDAS

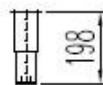

MFEI 70-225

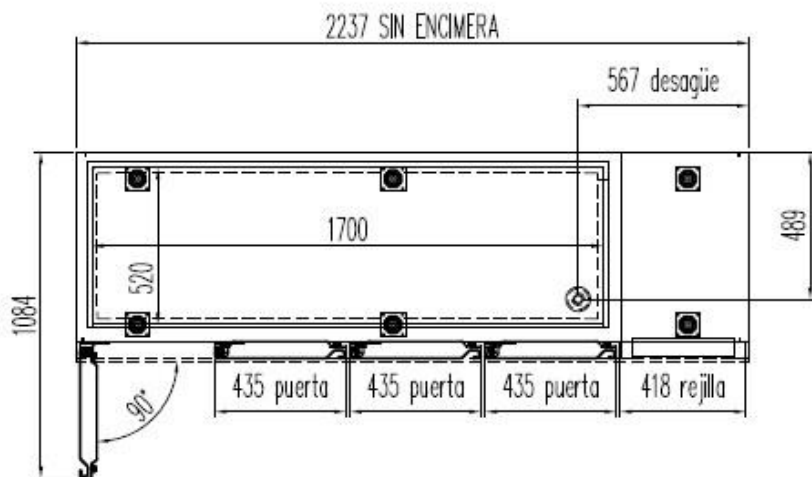
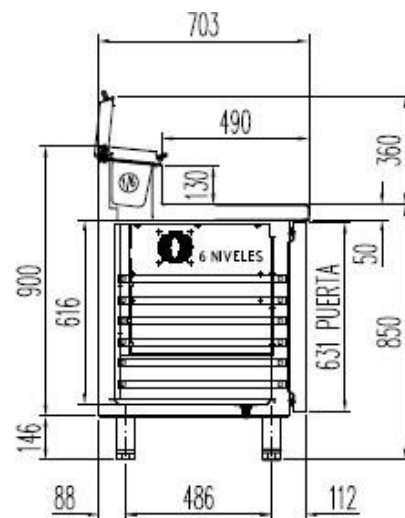
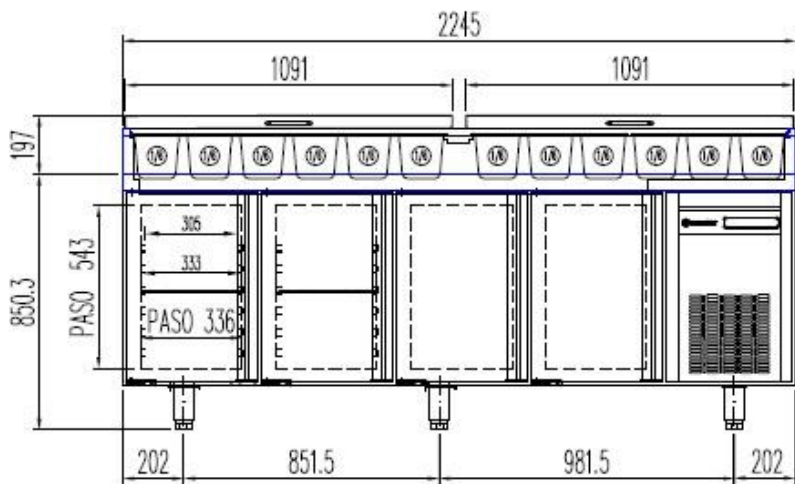

**PERFIL SIN ENCIMERA**

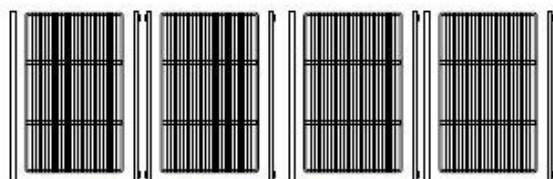
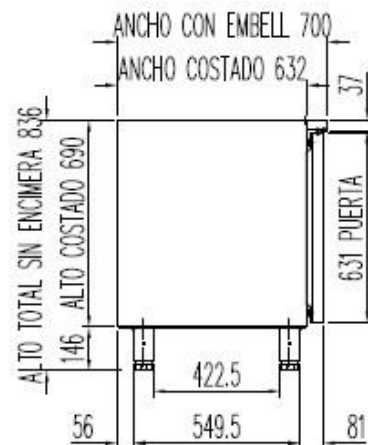

60277010003-PARRILLA ESTANTE 530 x325 mm GN 1/1  
 6033050027- JUEGO DE GUIAS EN "U" S62 mm

ENCIMERA CAPACIDAD HASTA  
 12 CUBETAS PROFUNDIDAD 150 mm.

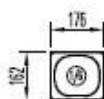

6041090012- CUBETA INOX 1/6 Prf. 150 mm

OPCIONAL  
 CAMBIO DE PATAS POR RUEDAS

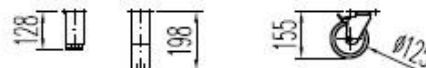

**MFEI 70-270**

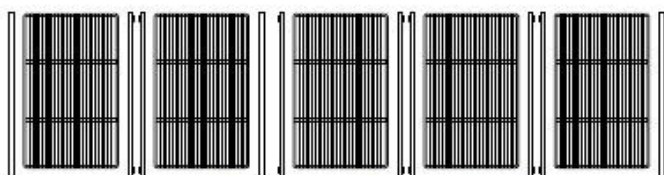
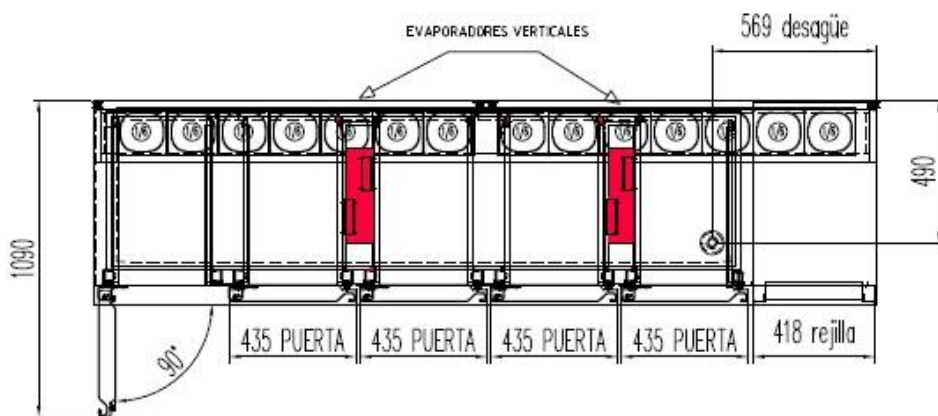
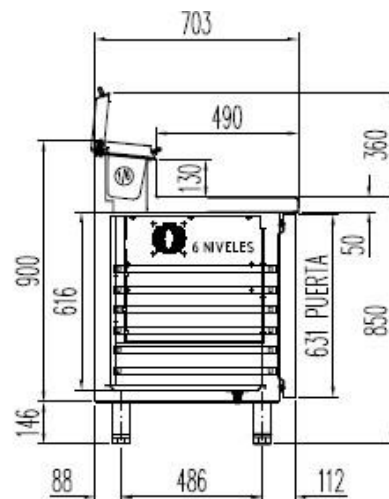
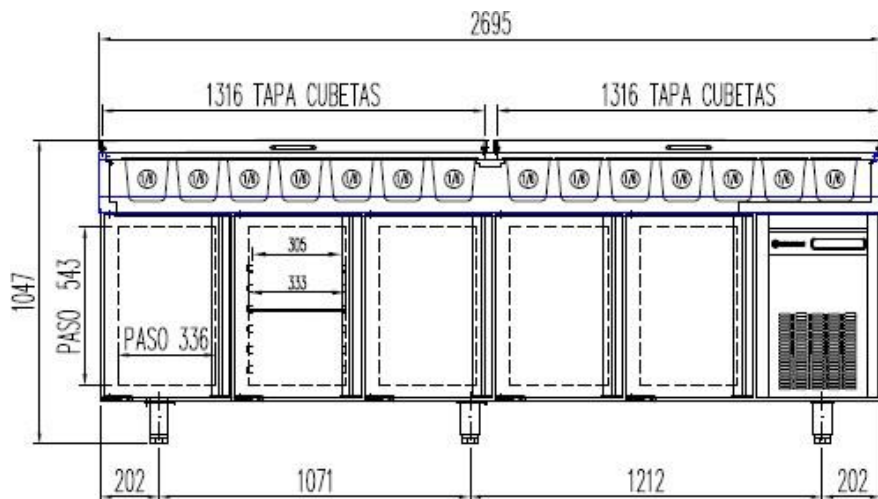

6027010003- PARRILLA ESTANTE 530 x 325 mm GN 1/1  
 6033050027- JUEGO DE GUIAS EN "U" 562 mm

ENCIMERA CAPACIDAD HASTA  
 14 CUBETAS PROFUNDIDAD 150 mm.

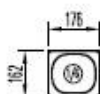

6041090012- CUBETA INOX 1/6 Prf. 150 mm

OPCIONAL

CAMBIO DE PATAS POR RUEDAS

