

MEUBLES PIZZA 600-700-800

Modèles MR60P-MR70P-MR80P



MR60-150-P
MR70-135-P
MR80-150-P



MR60-200-P
MR70-180-P
MR80-200-P

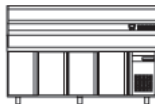

MR60-250-P
MR70-225-P
MR80-250-P



CARACTERISTIQUES TECHNIQUES

- Extérieur inox AISI-304 18/10 (sauf partie arrière)
- Intérieur inox AISI-304 18/10 avec angles arrondis et fond embouti
- 230/1/50 (60hz sur demande : PVP +5%)
- Porte réversible avec rappel de porte, charnières inox et joint magnétique déclinable. Reste ouverte au-delà de 90°
- Contre-porte emboutie inox
- Dessus granit avec dossier et joues de 180 mm
- Pieds inox réglables en hauteur de 135 à 210 mm
- Compresseur hermétique ventilé sur glissières
- Evaporateur entre portes ventilé traité anti corrosion
- Thermostat électronique avec afficheur digital, spécial économie d'énergie
- Evaporation automatique des eaux de dégivrage
- Isolation polyuréthane épaisseur 60 mm, densité 40kg/m³ sans effet GWP ou ODP
- Condenseur ventilé et extractible
- Alarme haute et basse température sur contrôleur digital
- **Vitrinette et bacs pour vitrinette non inclus**
- Conditions de travail : 32°C ambiant
- **MR60 - profondeur 600 (Snack)**
Livré avec 1 clayette rilsan par porte réglable en hauteur sur support inox
- **MR70 - profondeur 700 (GN 1/1)**
Livré avec 1 clayette inox GN 1/1 et 1 jeu de glissières inox par porte réglables en hauteur
- **MR80 - profondeur 800 (600x400)**
Livré avec 5 jeux de glissières inox par porte (sans clayette ou plaque) réglables. La porte extrême est livrée avec 3 jeux de glissières et 3 casiers plastiques 600x400x70

	Température	Nb portes	Dimensions (LxPxH mm)	Capacité (L)	Gaz	Puiss. frigo (W)	Conso. (W)
MR60-150-P	0°C/+8°C	2	1495x600x850	245	R134a*	178	211
					R290	502	235
MR60-200-P		3	2020x600x850	380	R134a*	245	249
					R290	502	238
MR60-250-P		4	2545x600x850	516	R134a*	304	289
					R290	845	355
MR70-135-P		2	1345x700x850	255	R134a*	178	211
					R290	502	235
MR70-180-P		3	1795x700x850	399	R134a*	245	249
					R290	502	238
MR70-225-P		4	2245x700x850	543	R134a*	304	289
					R290	845	355
MR80-150-P	2	1495x800x850	362	R134a*	178	211	
				R290	502	235	
MR80-200-P	3	2020x800x850	562	R134a*	245	249	
				R290	502	238	
MR80-250-P	4	2545x800x850	761	R134a*	304	289	
				R290	845	355	

* Non disponible pour le marché européen

OPTIONS

- Clayette rilsan
 - Kit 4 ou 6 roulettes
 - Serrure pour porte pleine
 - Arrière inox meuble 2, 3, 4 portes
 - Supplément pour avoir le groupe à gauche du meuble
 - Enregistreur d'alarmes HACCP
- **MR60** : support inox pour clayette
 - **MR70** :
Clayette inox GN 1/1
Jeu de 2 glissières inox GN 1/1 (L=560mm)
 - **MR80** :
Clayette inox pâtisseries 600x400
Jeu de 2 glissières en L (L=650mm)

SHEMAS TECHNIQUES

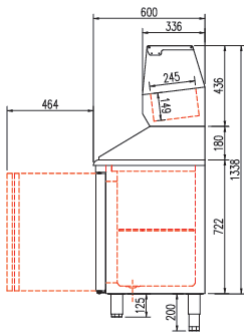

MR60

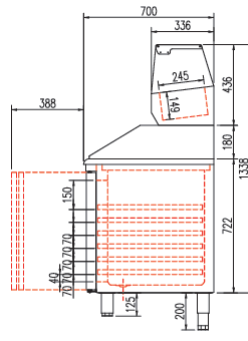

MR70

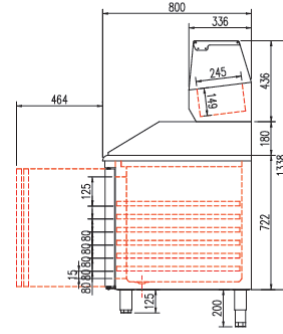

MR80

MR60-150

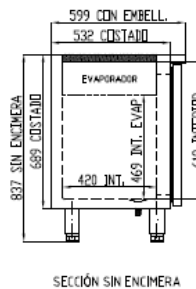
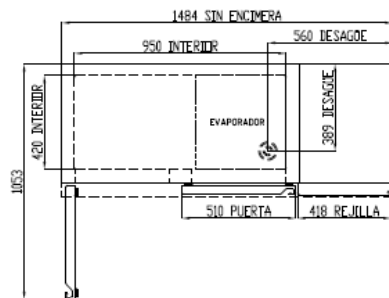
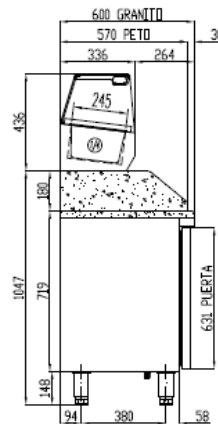
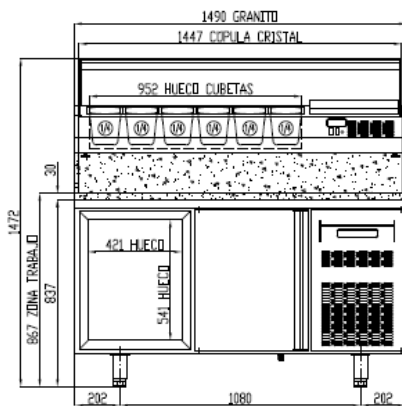

SECCIÓN SIN ENCIMERA



6 x GN 1/4 Prof. 150mm

MR60-200

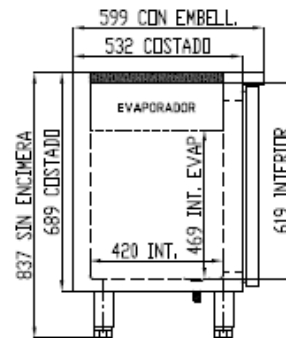
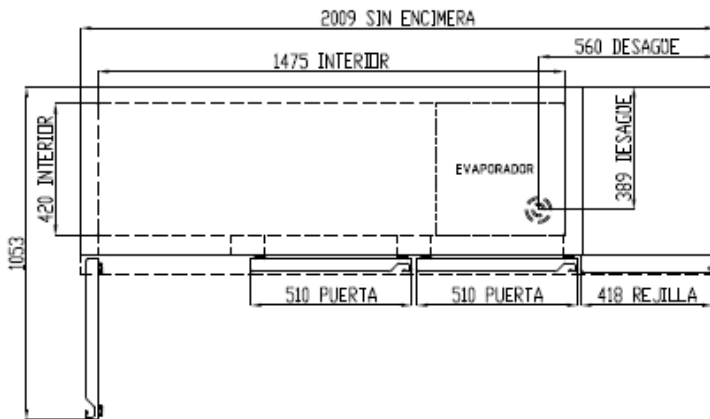
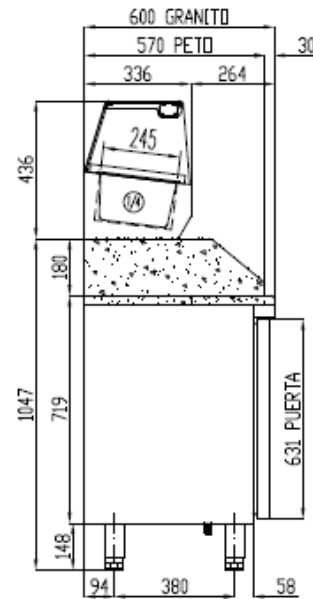
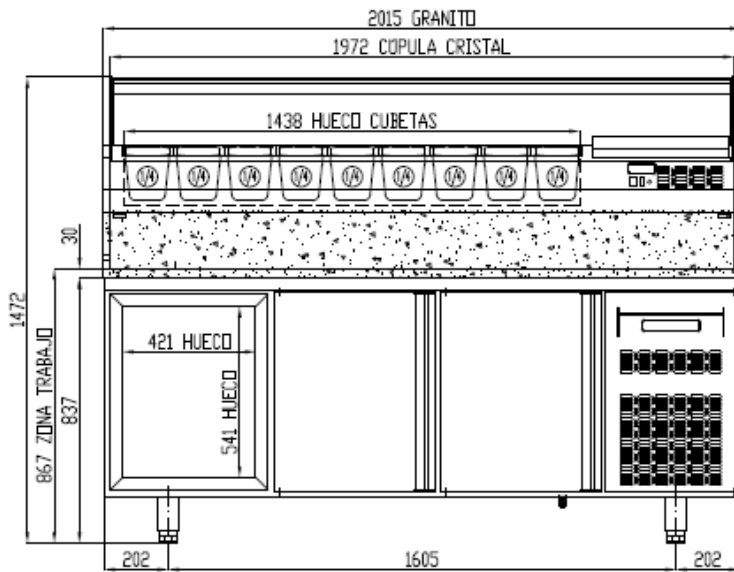

SECCIÓN SIN ENCIMERA

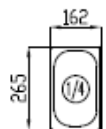

9 x GN 1/4 Prof. 150mm

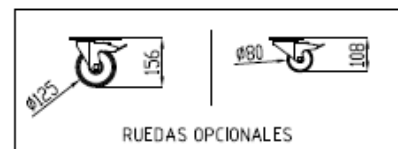

MR60-250

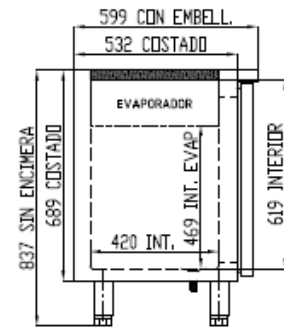
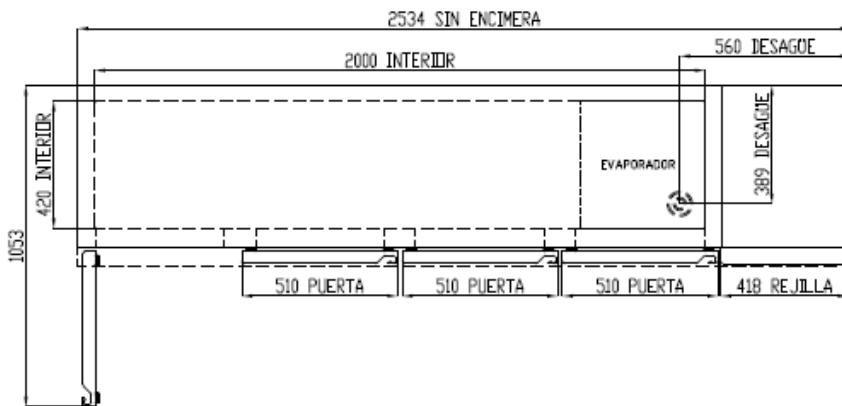
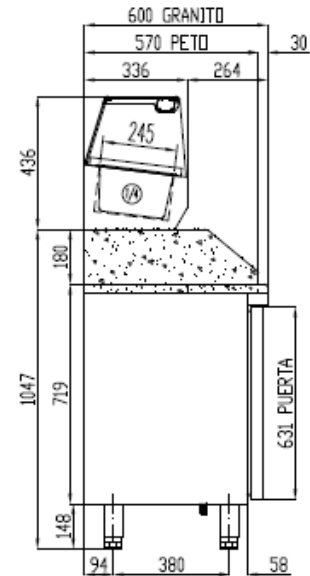
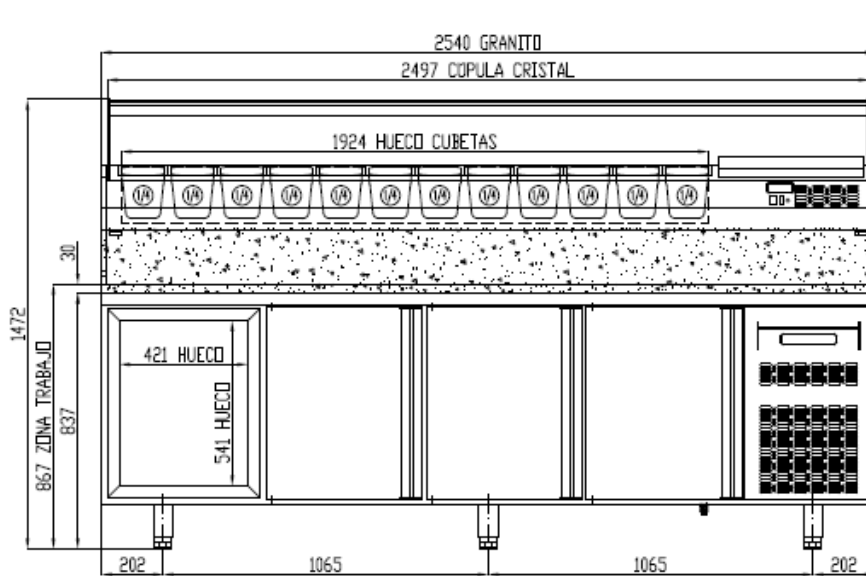

SECCIÓN SIN ENCIMERA

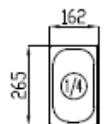

12 x GN 1/4 Prof. 150mm

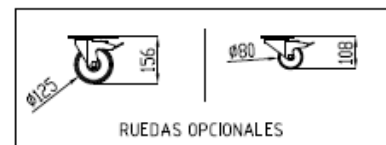

MR70-135

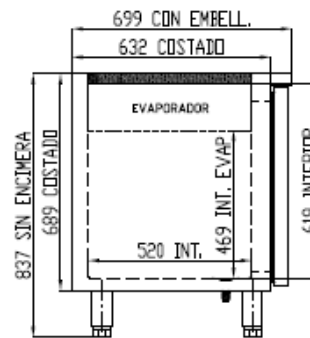
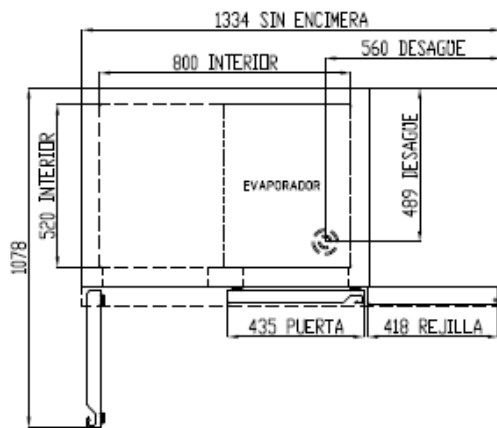
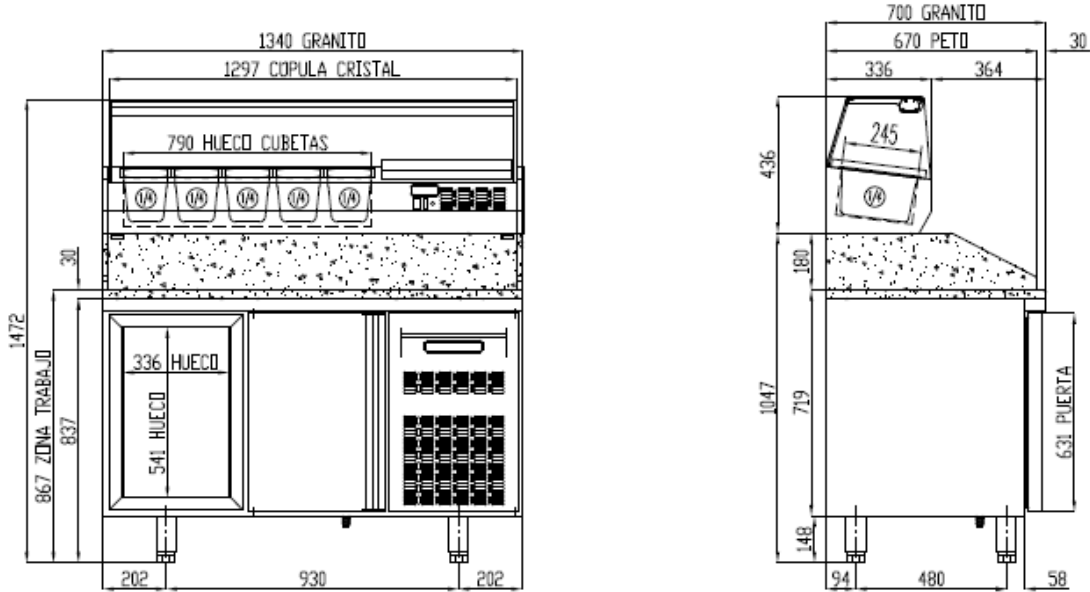

SECCIÓN SIN ENCIMERA

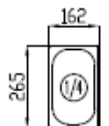

5 x GN 1/4 Prof. 150mm

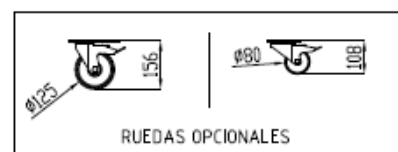
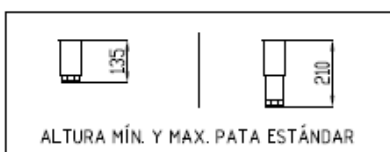

MR70-180

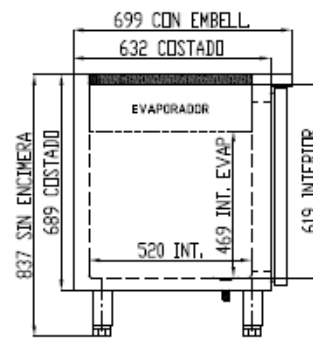
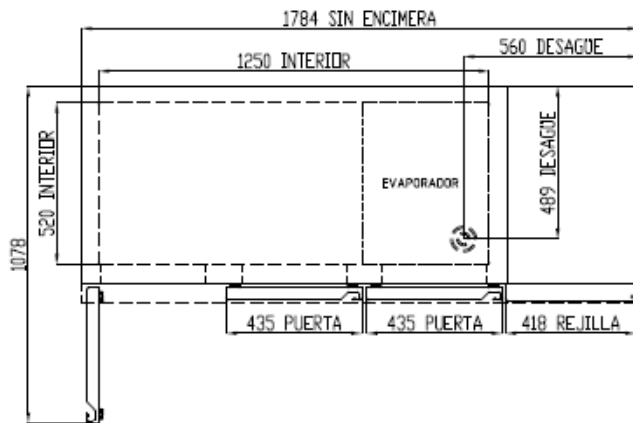
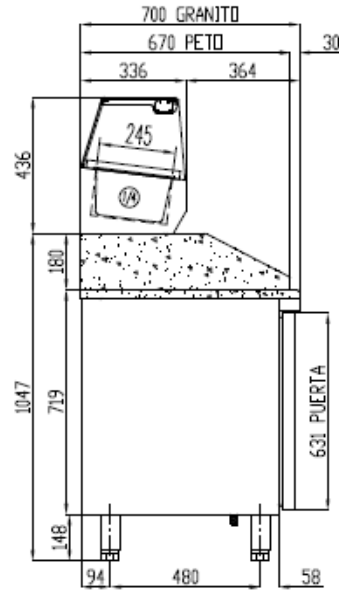
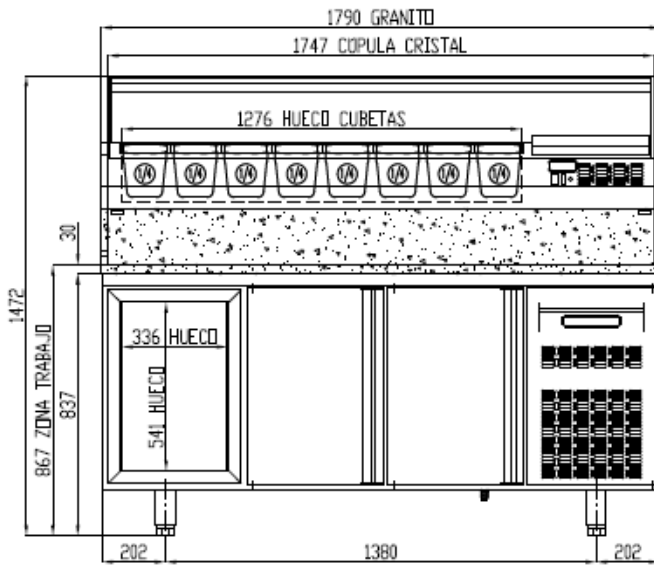

SECCIÓN SIN ENCIMERA

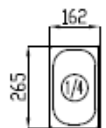

8 x GN 1/4 Prof. 150mm

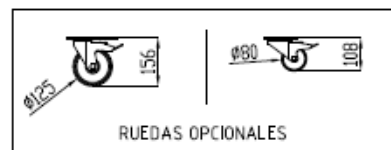

MR70-225

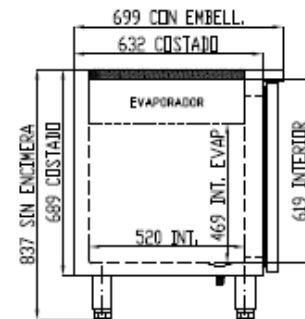
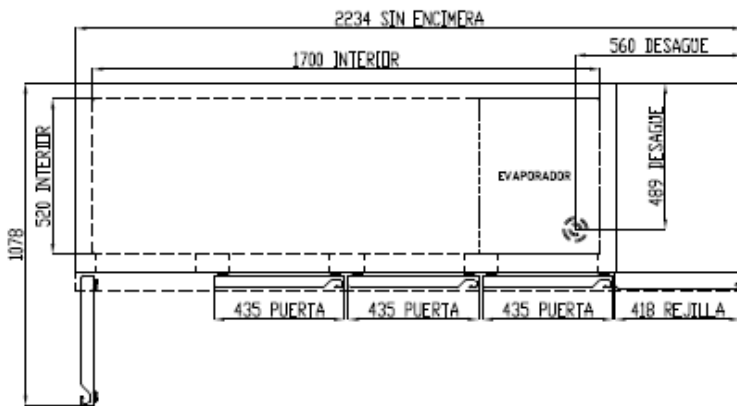
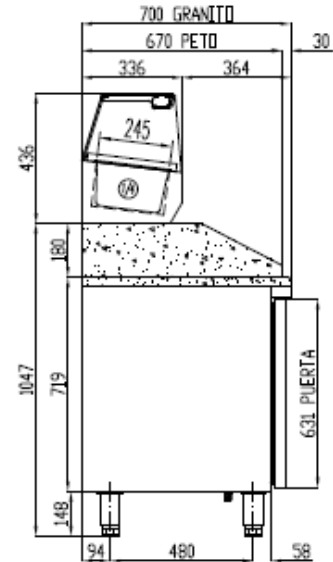
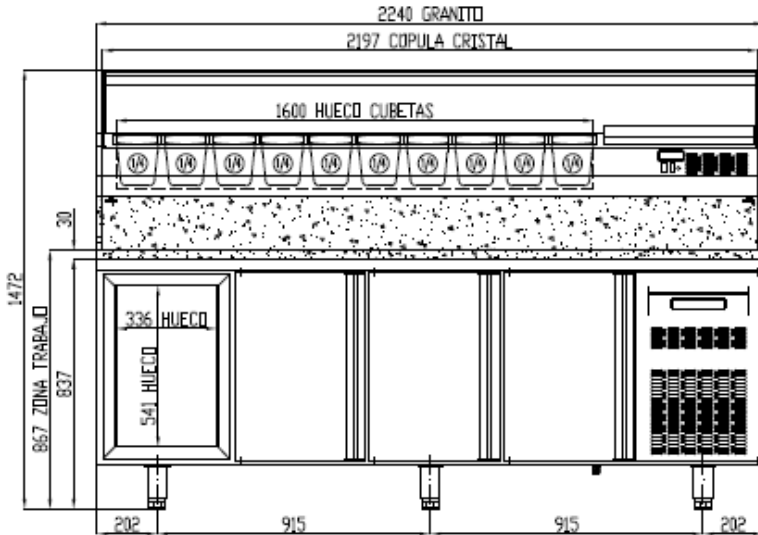

SECCIÓN SIN ENCIMERA

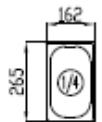

10 x GN 1/4 Prof. 150mm

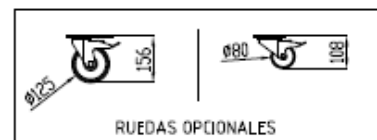

MR80-150

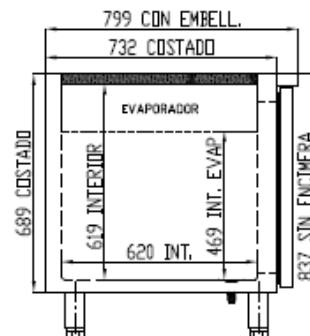
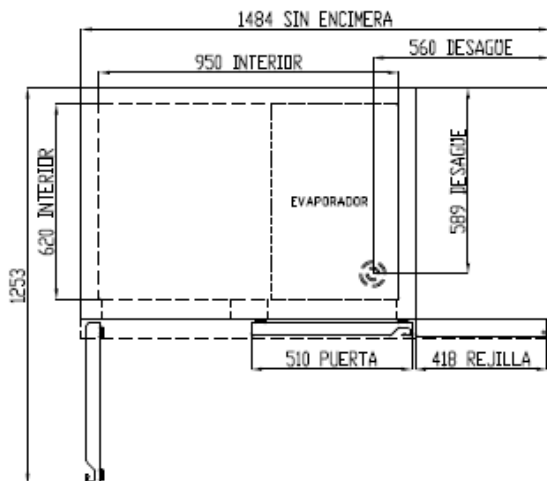
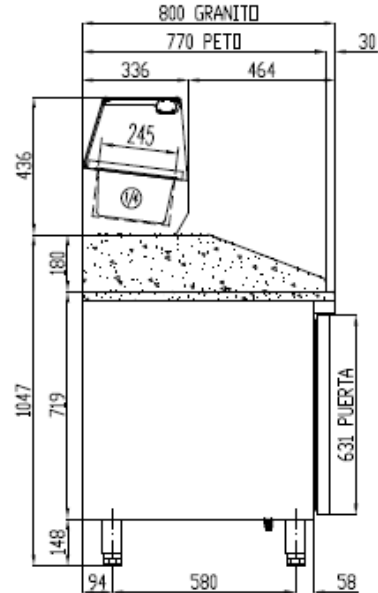
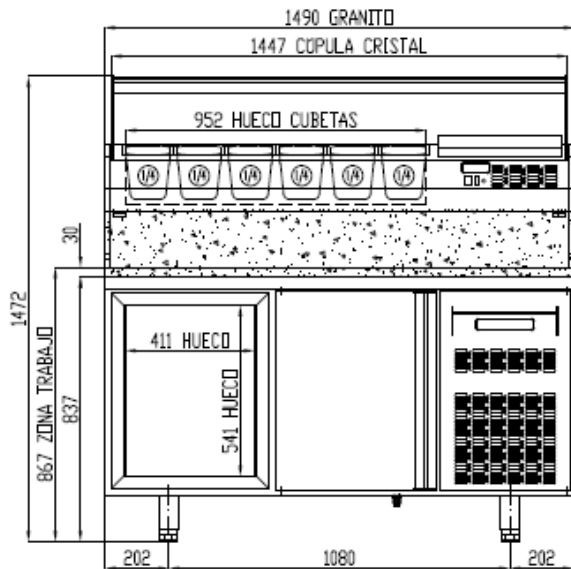

SECCIÓN SIN ENCIMERA

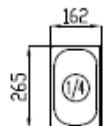

6 x GN 1/4 Prof. 150mm

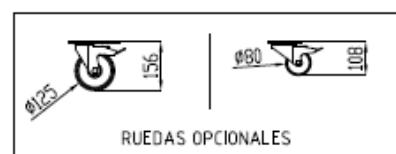
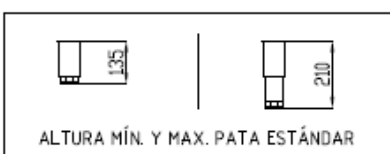

MR80-200

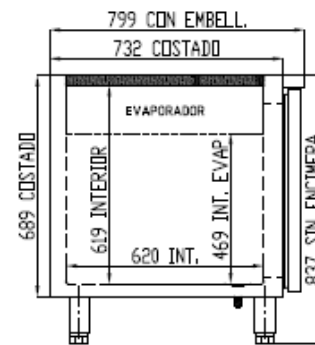
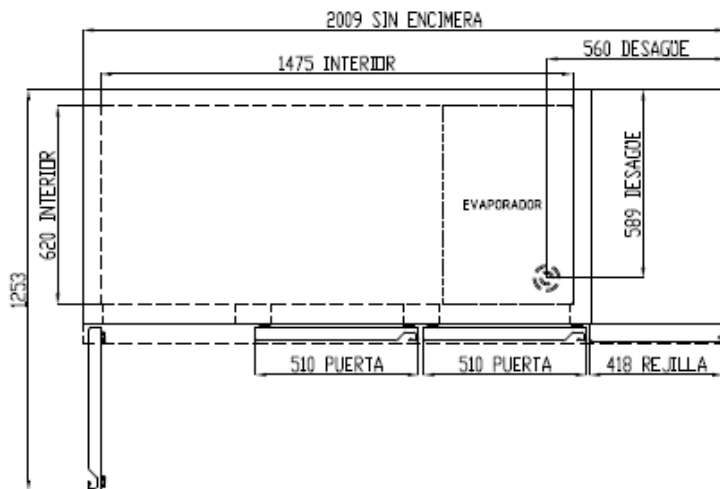
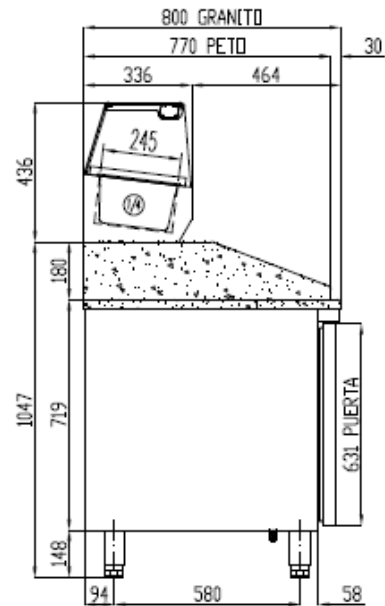
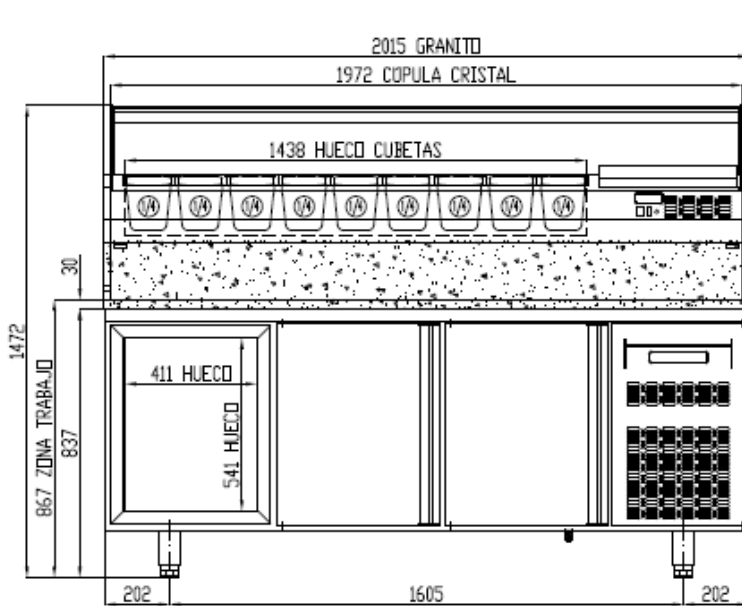

SECCIÓN SIN ENCIMERA

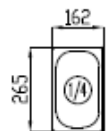

9 x GN 1/4 Prof. 150mm

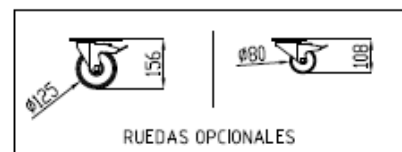

MR80-220

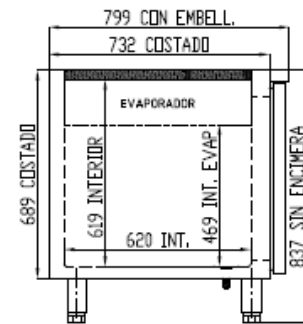
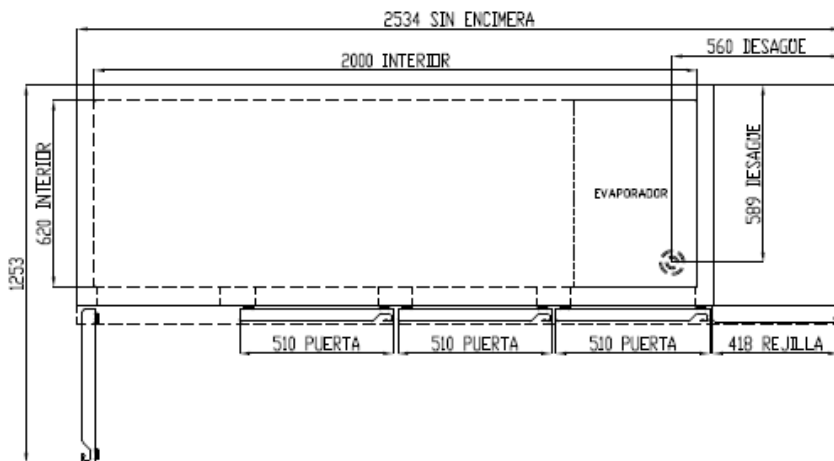
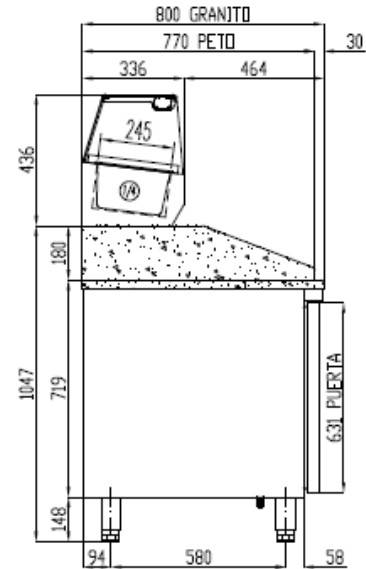
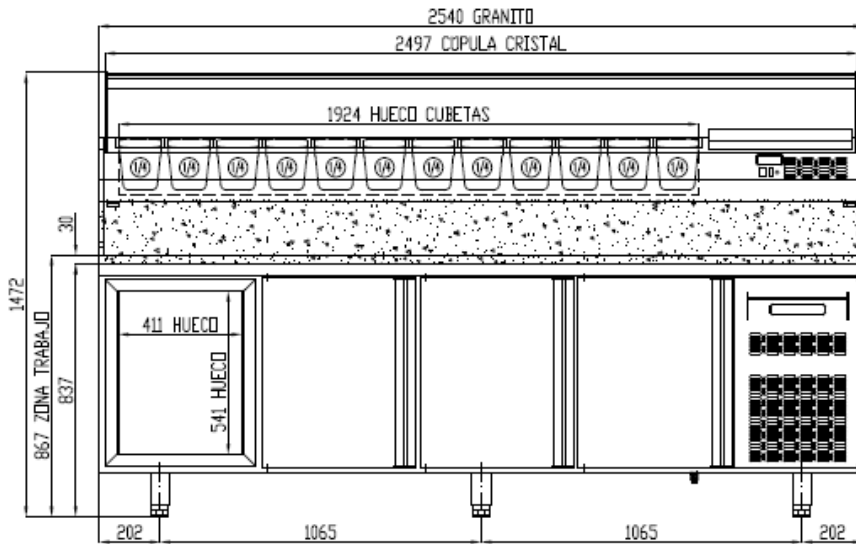

SECCIÓN SIN ENCIMERA

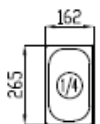

12 x GN 1/4 Prof. 150mm

