

SILO S350

CARACTÉRISTIQUES

- › BACS DE STOCKAGE D'UNE CAPACITE DE 340 KG
- › BACS DE STOCKAGE EN ACIER INOXYDABLE AISI 304
- › CUVE INTERIEURE EN POLYETHYLENE SANITAIRE DE GRANDE DURETE, RESISTANT AUX COUPS ET AUX RAYURES
- › EASY CLEANING DESIGN®: UNE SEULE PIÈCE SANS SOUDURE AVEC DES COINS ARRONDIS, POUR ÉVITER DES COUPS POSSIBLES ET POUR FACILITER DU NETTOYAGE
- › SYSTEME DE DRAINAGE PERMETTANT DE COLLECTER ET DE CONDUIRE L'EAU VERS LA VIDANGE EN CONSERVANT LE BAC PROPRE ET SEC



MACHINES RECOMMANDEE

MDP150/MR400/MP



2 MDP150

SPIKA



1/2 MS220



MS300 SLIM



1/2 MS410

QUASAR



MQ200

ICE QUEEN



2 IQ150



1/2 IQ200



IQ400



IQ550



1/2 IQ550 SPLIT



1/2 IQ850 CO2 SPLIT



IQ1100 SPLIT



MDP150



MP145



IQ150



SCALA 400
SCALA 400 SPLIT

ACCESSOIRES



KIT DE 4 PIEDS REGLABLES
EN HAUTEUR



GRANDE PELLE



TUYAU
D'ÉVACUATION



COUDE DE
VIDANGE

SCHÉMAS TECHNIQUES





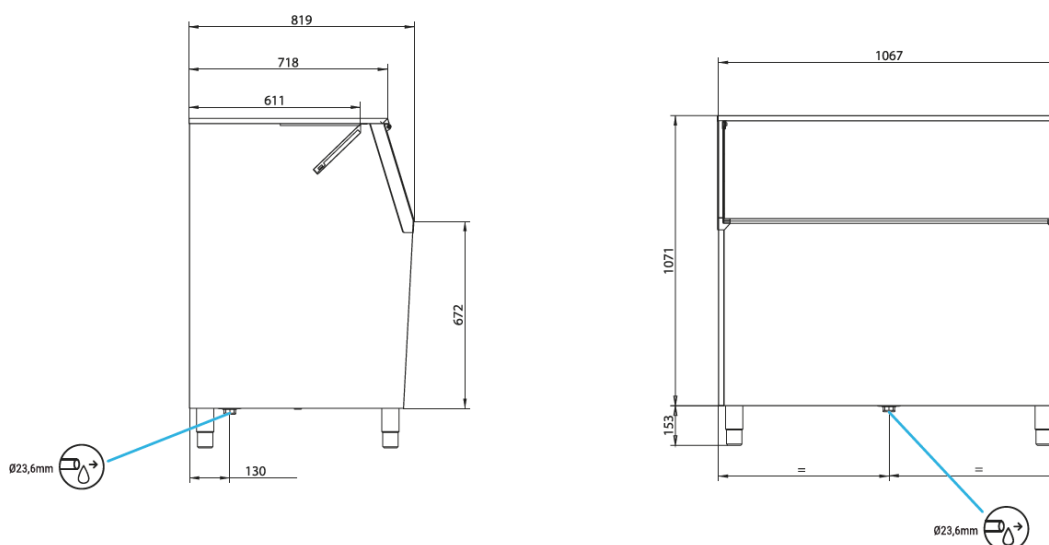

VUE DE DROITE

VUE FRONTALE

*Toutes les côtes sont en mm



CONDITIONS DE FONCTIONNEMENT

	 (Kg)	 (mm)	 (Kg)	 (mm)	 (Kg)	 (m ³)
SILO S350	340	Width 1.067 Depth 819 Height 1.071	69	Width 1.150 Depth 890 Height 1.210	90	1,24

*1224 mm avec pieds