

SILO SCD400

CARACTÉRISTIQUES

- ▶ PARTIE SUPÉRIEURE D'UNE CAPACITÉ DE 413 KG (CAPACITÉ DU CHARRIOT NON INCLUS)
- ▶ CARROSSERIE EXTERIEURE EN ACIER INOXYDABLE AISI 304
- ▶ CUVE INTERIEURE EN POLYETHYLENE SANITAIRE DE GRANDE DURETE, RESISTANT AUX COUPS ET AUX RAYURES
- ▶ EASY CLEANING DESIGN®: UNE SEULE PIÈCE SANS SOUDURE AVEC DES COINS ARRONDIS, POUR ÉVITER DES COUPS POSSIBLES ET POUR FACILITER DU NETTOYAGE
- ▶ SYSTEME DE DRAINAGE PERMETTANT DE COLLECTER ET DE CONDUIRE L'EAU VERS LA VIDANGE EN CONSERVANT LE BAC PROPRE ET SEC
- ▶ GRANDE CAPACITÉ EASY CART® : JUSQU'A 112 KG DE GLACE (70 KG AVEC SCEAUX), ERGONOMIQUE, FACILE A DEPLACER AVEC PEU D'EFFORT
- ▶ EASY CART® DISPOSE D'UN SYSTEME DE FREINAGE ET DE VIDANGE
- ▶ EASY CART® EST EN POLYÉTHYLÈNE SANITAIRE, À SURFACE LISSE POUR FACILITER LE NETTOYAGE. IL COMPREND UNE COUVERTURE POUR EMPÊCHER LA SALETTE DE CONTAMINER LA GLACE.
- ▶ LES SCEAUX POUR DISTRIBUER LA GLACE RAPIDEMENT ET SANS EFFORT PEUVENT ÊTRE INCLUS



MACHINES RECOMMANDÉES

MDP150/MR400/MP



SPIKA



ICE QUEEN



SCALA



ACCESSOIRES



TUYAU
D'ÉVACUATION



GRANDE PELLE



PELLE A GLACE A LONG
MANCHE



SUPPORT POUR
LA PELLE A
GLACE







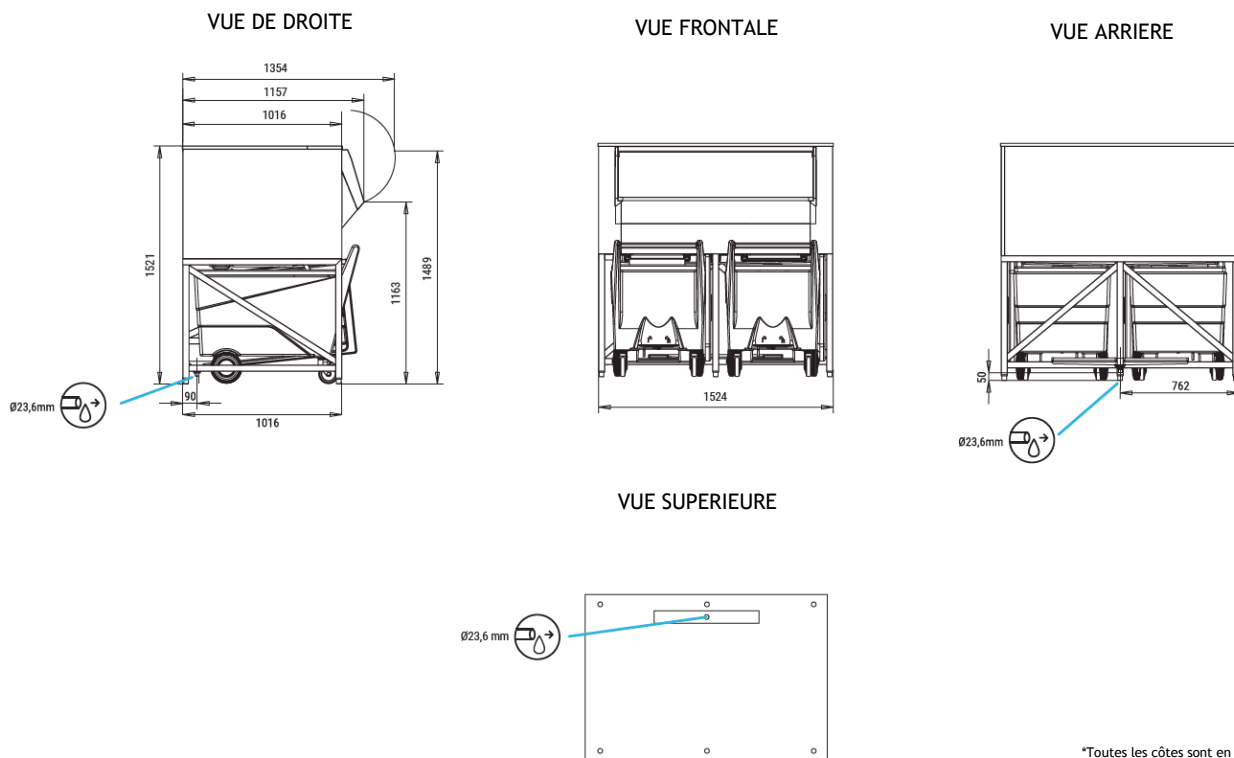



SCEAUX

SCHÉMAS TECHNIQUES



CONDITIONS DE FONCTIONNEMENT

	 (Kg)	 (Kg)	 (Kg)	 (mm)	 (Kg)	 (mm)	 (Kg)	 (m³)
BIN SCD400	413	330	637	Width 1.524 Depth 1.016* Height 1.520	140	Width 1.630 Depth 1.240 Height 1.660	235	3,36

*Sans porte