

SILO SCD600

CARACTÉRISTIQUES

- ▶ PARTIE SUPÉRIEURE D'UNE CAPACITÉ DE 617 KG (CAPACITÉ DU CHARRIOT NON INCLUS)
- ▶ CARROSSERIE EXTERIEURE EN ACIER INOXYDABLE AISI 304
- ▶ CUVE INTERIEURE EN POLYETHYLENE SANITAIRE DE GRANDE DURETE, RESISTANT AUX COUPS ET AUX RAYURES
- ▶ EASY CLEANING DESIGN®: UNE SEULE PIÈCE SANS SOUDURE AVEC DES COINS ARRONDIS, POUR ÉVITER DES COUPS POSSIBLES ET POUR FACILITER DU NETTOYAGE
- ▶ SYSTEME DE DRAINAGE PERMETTANT DE COLLECTER ET DE CONDUIRE L'EAU VERS LA VIDANGE EN CONSERVANT LE BAC PROPRE ET SEC
- ▶ GRANDE CAPACITÉ EASY CART® : JUSQU'À 112 KG DE GLACE (70 KG AVEC SCEAUX), ERGONOMIQUE, FACILE À DÉPLACER AVEC PEU D'EFFORT
- ▶ EASY CART® DISPOSE D'UN SYSTEME DE FREINAGE ET DE VIDANGE
- ▶ EASY CART® EST EN POLYÉTHYLÈNE SANITAIRE, À SURFACE LISSE POUR FACILITER LE NETTOYAGE. IL COMPREND UNE COUVERTURE POUR EMPÊCHER LA SALETTE DE CONTAMINER LA GLACE.
- ▶ LES SCEAUX POUR DISTRIBUER LA GLACE RAPIDEMENT ET SANS EFFORT PEUVENT ÊTRE INCLUS



MACHINES RECOMMANDÉES

MDP150/MR400/MP



2 MDP150



MR400

SPIKA



2 MS220



1/2 MS410

ICE QUEEN



1/2 IQ400



1/2 IQ550



1/2 IQ550 SPLIT



IQ850 CO2SPLIT



IQ1100



IQ1100 SPLIT

SCALA



SCALA 400
SCALA 400 SPLIT



SCALA 600
SCALA 600 SPLIT



SCALA
1000/1500/2000/3000
SPLIT

ACCESSOIRES



TUYAU
D'ÉVACUATION



GRANDE PELLE



PELLE À GLACE À LONG
MANCHE



SUPPORT POUR
LA PELLE À
GLACE







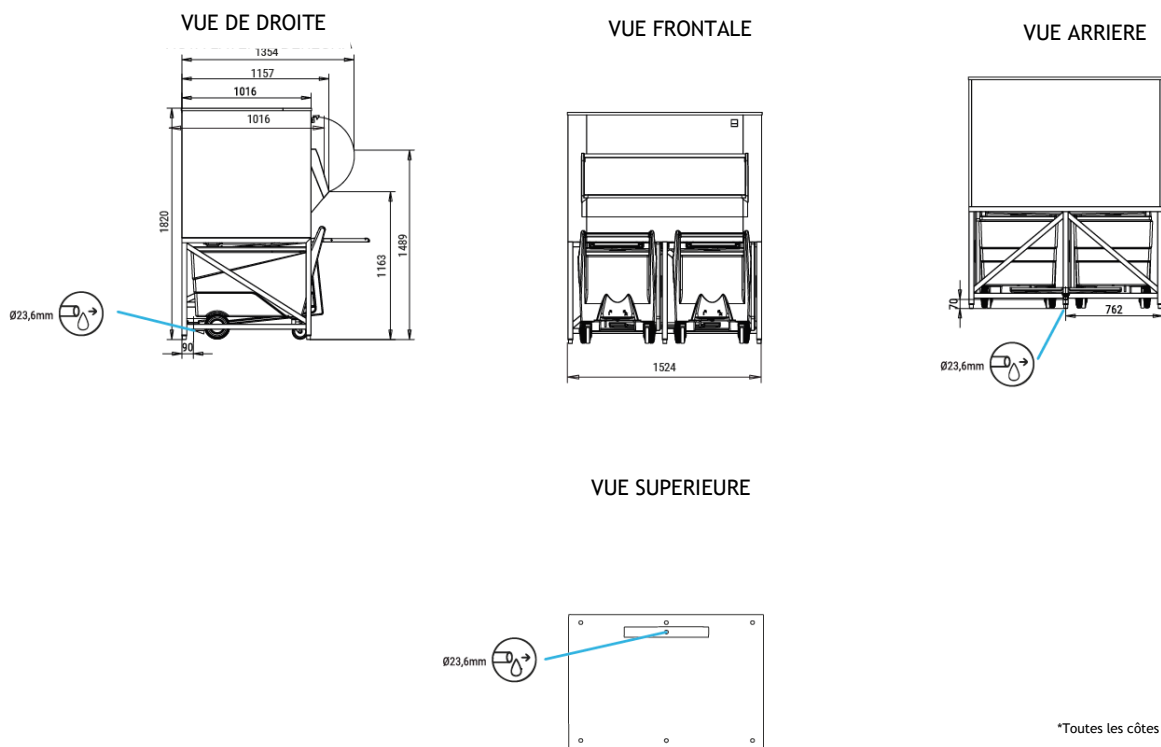



SCEAUX

SCHÉMAS TECHNIQUES



*Toutes les côtes sont en mm.

CONDITIONS DE FONCTIONNEMENT

	 (Kg)	 (Kg)	 (Kg)	 (mm)	 (Kg)	 (mm)	 (Kg)	 (m³)
SILO SCD600	617	494	841	Width 1.524 Depth 1.016* Height 1.820	160	Width 1.630 Depth 1.240 Height 1.980	255	4

*Sans porte