

MEUBLES GASTRO 700

Modèles TGR-S et TGC-S

Restauration S-Line - Portes pleines ou vitrées

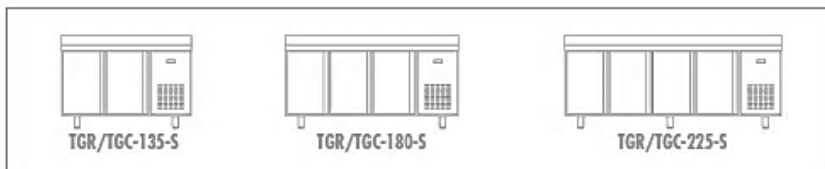

CARACTERISTIQUES TECHNIQUES

- Extérieur inox AISI-304 (sauf partie arrière en galva)
- Intérieur inox AISI-304 avec angles arrondis et fond embouti
- Dossieret de 100 mm (pas de sans dossieret)
- Joints de portes magnétiques démontables plastifiés
- Evaporation automatique des eaux de dégivrage
- Groupe extractible sur glissière avec compresseur tropicalisé
- Pieds inox réglables de 135 à 210 mm
- Thermostat électronique avec afficheur digital, spécial économie d'énergie
- Alarme haute et basse température sur contrôleur digital
- 230/1/50 (60hz sur demande : PVP +5%)
- Livré avec 1 clayette rilsan GN 1/1 et 1 jeu de glissières inox par porte, réglable en hauteur
- Conditions de travail : TGR 40°C ambiant, TGC 32°C ambiant

	Température	Nb portes	Dimensions (LxPxH mm)	Capacité (L)	Gaz	Puiss. frigo (W)	Conso. (W)	CCE	Classe climatique
TGR-135-S	-2°/+8°C	2	1345x700x850	255	R134a*	178	211	C	5 40°C 40%
					R290	502	235	B	5 40°C 40%
TGR-180-S		3	1795x700x850	399	R134a*	245	249	D	5 40°C 40%
					R290	502	238	B	5 40°C 40%
TGR-225-S		4	2245x700x850	543	R134a*	304	289	C	5 40°C 40%
					R290	845	379	C	5 40°C 40%
TGC-135-S	-20°/-15°C	2	1345x700x850	255	R290	606	535	E	4 30°C 55%
					R449A*	353	556	E	4 30°C 55%
TGC-180-S		3	1795x700x850	399	R290	606	556	E	4 30°C 55%
					R449A*	452	610	E	4 30°C 55%

* Non disponible pour le marché européen

OPTIONS

- Clayette rilsan GN 1/1
- Jeux de 2 glissières inox GN 1/1 (L=550 mm)
- Changement de gaz sur modèles positifs (R290 → R134a)
- Changement de gaz sur modèles négatifs (R290 → R449A)

SCHEMAS TECHNIQUES

TGR/TGC-135-S

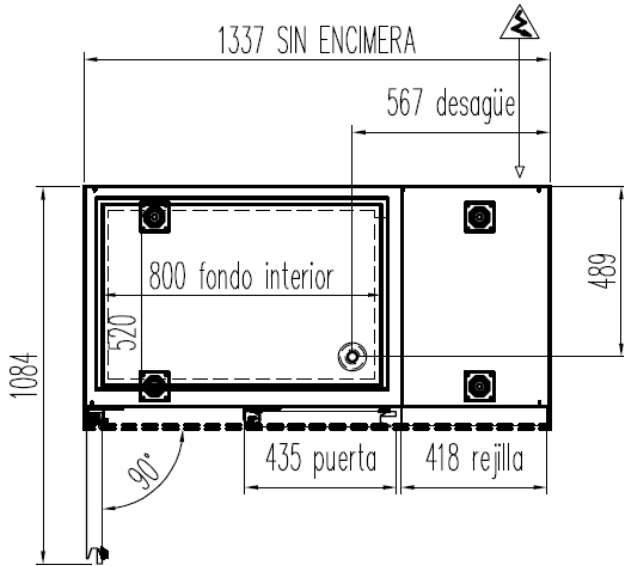
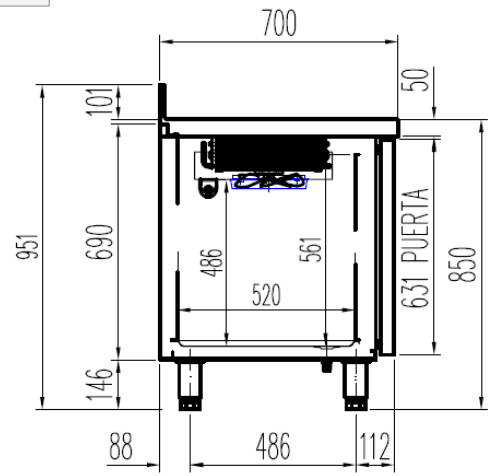
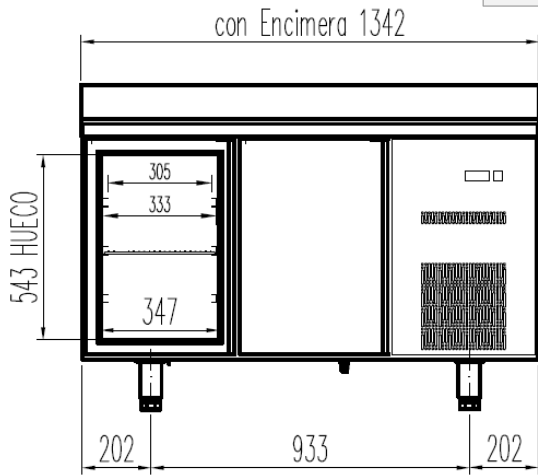

PERFIL SIN ENCIMERA

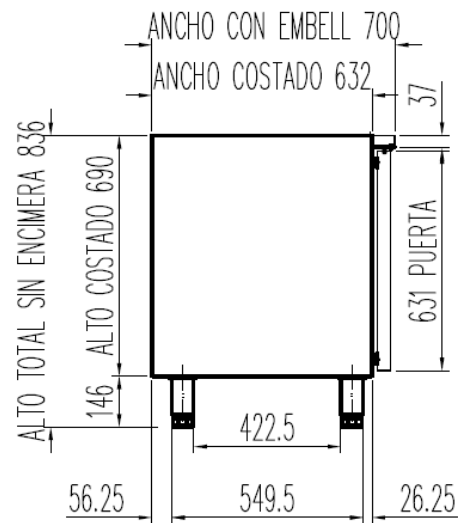

ENERG
CORCO TGR-135-S

A, B, C, D, E, F, G

C

986 kWh/annum

160 L

5 40°C-40%

2015/1094-1

Ficha de Producto
Product Fiche

Modelo Model
CORCO TGR-135-S

Typo	COUNTER CABINET CHILLER
Clase Eficacia Energética	C
Indice Eficacia Energética	44,82 EEI
Consumo Energía Diario	2,7 kW
Consumo Energía Anual	985,5 kW
Volumen Neto Refrigerador	160 L
Volumen Neto Congelación	- L
Clase Climática	5 40 °C 40 rH %

This appliance is intended for use in ambient temperatures up to 40°C

heavy duty cabinet

2015/1094

OPCIONAL

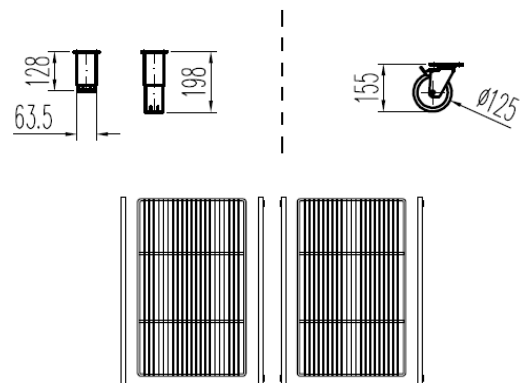

TGR/TGC-180-S

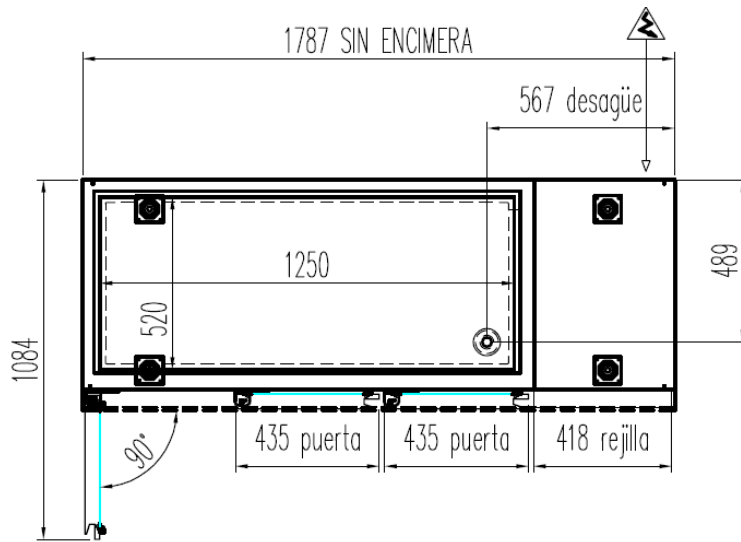
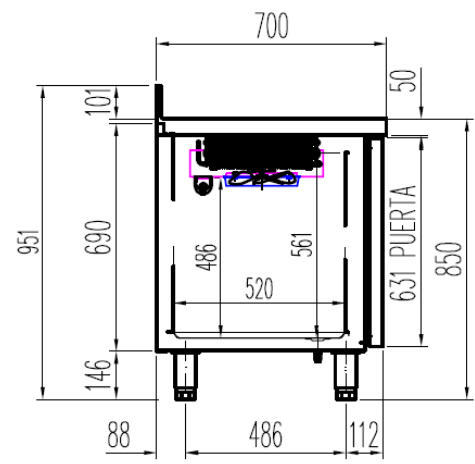
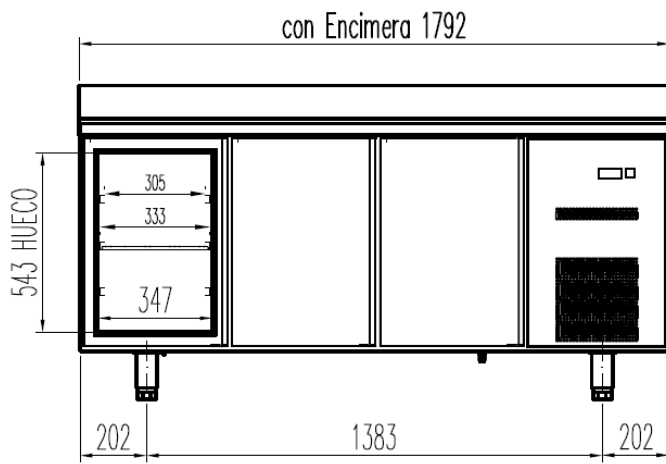

PERFIL SIN ENCIMERA

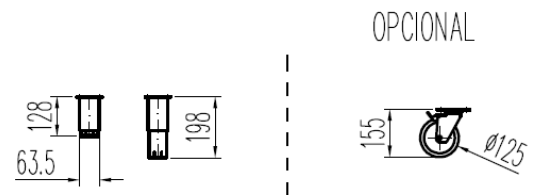
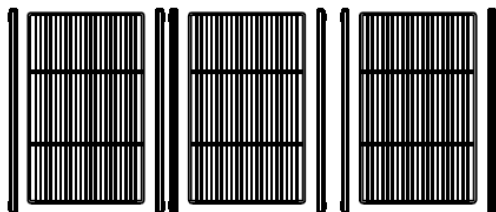
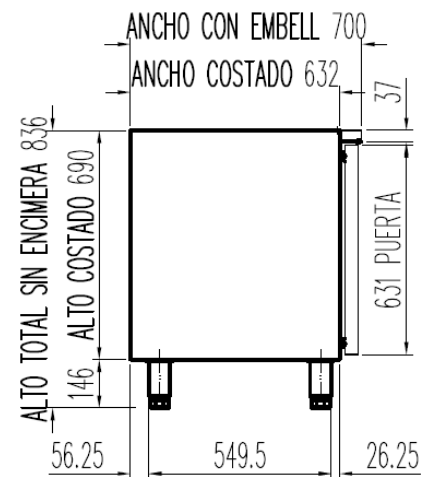

TGR-225-S

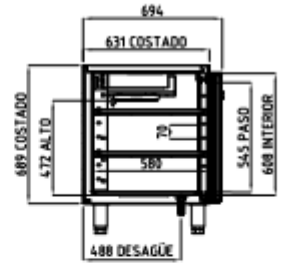
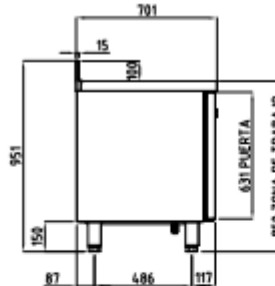
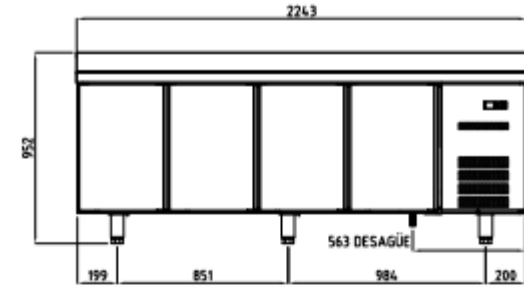

SECCIÓN SIN ENCIMERA

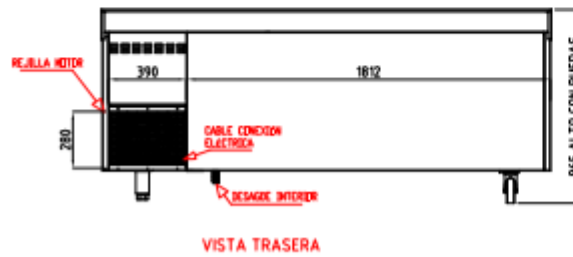
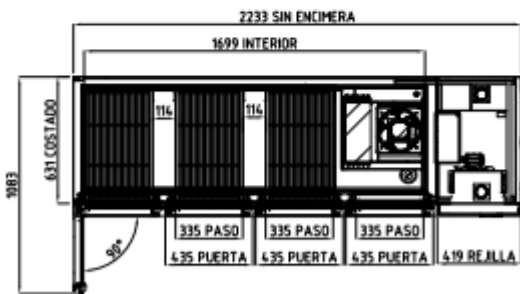
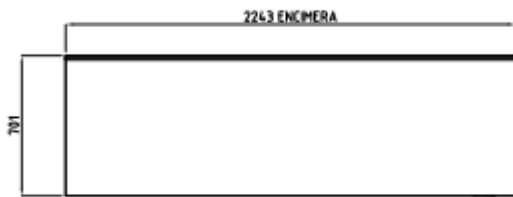

VISTA TRASERA



6027010003-PARRILLA ESTANTE 538 x325 mm GN 1/1
 6033050027- JUEGO DE GUÍAS EN 1/2"

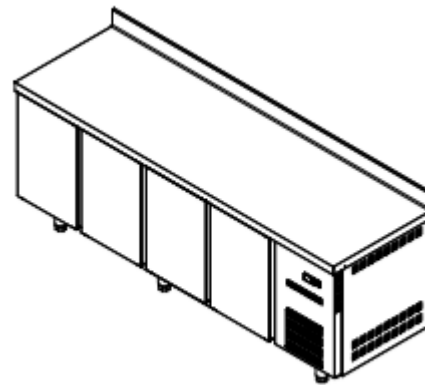

Cotas en mm